

ДИАМ
современная лаборатория

www.dia-m.ru
заказ on-line

D LAB

Высокоскоростная микроцентрифуга D3024



руководство по эксплуатации

CE FC
12301572

Ver.20211215

ООО «Диаэм»

Москва

ул. Магаданская, д. 7, к. 3 ■ тел./факс: (495) 745-0508 ■ sales@dia-m.ru

www.dia-m.ru

С.-Петербург
+7 (812) 372-6040
spb@dia-m.ru

Новосибирск
+7 (383) 328-0048
nsk@dia-m.ru

Воронеж
+7 (473) 232-4412
vrn@dia-m.ru

Йошкар-Ола
+7 (927) 880-3676
nba@dia-m.ru

Красноярск
+7 (923) 303-0152
krsk@dia-m.ru

Казань
+7 (843) 210-2080
kazan@dia-m.ru

Ростов-на-Дону
+7 (863) 303-5500
rnd@dia-m.ru

Екатеринбург
+7 (912) 658-7606
ekb@dia-m.ru

Кемерово
+7 (923) 158-6753
kemerovo@dia-m.ru

Армения
+7 (094) 01-0173
armenia@dia-m.ru



Contents

SAFETY REMINDER.....	1
1. SPECIFICATIONS.....	5
2. DECLARATION OF CONFORMITY.....	6
3. REQUIRED OPERATIONAL CONDITION.....	7
3.1 BASIC OPERATIONAL CONDITIONS.....	7
3.2 TRANSPORT AND STORAGE CONDITION.....	7
4. INSTALLATION.....	8
4.1 LOCATION.....	8
4.2 CONNECTION OF THE POWER CORD AND GROUNDING.....	9
5. STRUCTURE.....	10
6. OPERATION PANEL.....	11
7. ROTOR PREPARATION.....	14
7.1 PREPARE THE SAMPLES.....	14
7.2 INJECT THE SAMPLES INTO TUBES.....	14
7.3 KEEP THE TUBES BALANCE.....	14
7.4 INSPECT THE ROTOR.....	14
7.5 SYMMETRICALLY LOAD CENTRIFUGE TUBES IN ROTOR.....	15
8. OPERATION.....	15
8.1 NORMAL OPERATION.....	15

8.2 RCF OPERATION	21
8.3 PULSE OPERATION	22
9. MAINTENANCE	23
9.1 CLEANING	23
9.2 CONSUMABLES	25
9.3 THE REPLACEMENT OF SEAL RINGS	25
9.4 ROUTINE INSPECTION	26
10. TROUBLESHOOTING	27
10.1 POSSIBLE PROBLEMS AND SOLUTIONS	27
10.2 HOW TO OPEN THE DOOR	28
11. INSTRUCTIONS OF ROTOR AND TUBE	29
11.1 THE ROTOR INSTRUCTIONS	30
11.2 TUBES	33
12. CALCULATION RELATIVE CENTRIFUGE FORCE (RCF)	36
13. WARRANTY	36
13.1 WARRANTY OF THE CENTRIFUGE	36
13.2 WARRANTY OF THE ROTOR	36
14. AFTER-SALES SERVICE	37

Safety Reminder

Common safety precautions

Carefully read the following safety precautions for a thorough understanding.

- Follow the instructions and procedures described in this manual to operate this centrifuge safely.
- Carefully read all safety messages in this manual and the safety instructions on the instrument.
- Safety messages are labeled as indicated below. They are in combination with signal words of “WARNING” and “CAUTION” with the safety alert symbol to call your attention to items or operations that could be dangerous to you or other persons using this instrument. The definitions of signal words are as follows:

 **WARNING:** Personal Danger

Warning notes indicate any condition or practice, which if not strictly observed, could result in personal injury or possible death.

 **CAUTION:** Possible damage to instrument

Caution notes indicate any condition or practice, which if not strictly observed or remedied, could result in damage or destruction of the instrument.

NOTE: Notes indicate an area or subject of special merit, emphasizing either the product's capability or common errors in operation or maintenance.

- Do not operate this centrifuge in any manner not described in this User manual. When in doubt or have any troubles with this centrifuge, ASK FOR HELP.
- The precautions described in this User manual are carefully developed in an attempt to cover all the possible risks. However, it is also important that you are alert for unexpected incidents. Be carefully operating this centrifuge.

**WARNING:**

- This centrifuge is not explosion-proof. Never use explosive or flammable samples.
- Do not install the centrifuge in or near places where inflammable gases are generated or chemicals are stored.
- Do not place dangerous material within 30cm around the centrifuge.
- Make sure to prepare necessary safety measures before using samples that

are toxic, radioactive or contaminated with pathogenic micro-organisms at your own responsibility.

- If the instrument, rotor and/or accessories that has been contaminated by solutions with toxic, radioactive or pathogenic materials, clean it according to the decontamination procedure that you are specified.
- If you require services at site, please sterilize and decontaminate it in advance, and then notice the service center involved in the details of the particular materials.
- Do not handle the power cord or turn on or off the POWER switch with wet hands to void electrical shocks.
- For safety purposes, do not enter within 30cm around this centrifuge while it is in operation.
- While the rotor is rotating, never forcedly release the door lock.
- Unauthorized repairs, disassembly, and other services to the centrifuge except by our service center are strictly prohibited.

 CAUTION

- This centrifuge must be located on one firm and level table.
- Make sure the centrifuge is horizontal before running.
- Make sure the angle between the door and cover is greater than 70 degrees when open the door.
- Be careful not put your fingers or hands between the door and cover when the

door off.

- Do not move or relocate this centrifuge while it is running.
- If fluid spills in the rotor chamber, please promptly clean and dry with a dry cloth to avoid sample contamination.
- Ensure to remove any objects and fragments of the tubes dropped inside the rotor chamber before running this centrifuge.
- Cautions on rotors
 - (1) Always check for corrosion and damages on the rotor surface before using it. Do not use the rotor if an abnormality is found.
 - (2) Do not set the centrifuge speed beyond the allowable minimum speed of the rotor kits (rotor or adapters). Make sure to run it below the allowable minimum speed.
 - (3) Do not exceed the allowable imbalance.
 - (4) Use the rotor and tubes within their actual capacities.
 - (5) If the rotor is attached with a lid, ensure it is tightened before operation.
- If any abnormal condition occurs during operation, please stop it immediately and contact our service center. Notify the service center is a warning code if displayed.
- Vibrations are likely to damage the centrifuge, contact our service center if abnormality observed.

1. Specifications

Maximum speed	15000rpm(200-15000rpm), increment:10rpm
Maximum RCF	21380×g, increment:10×g
Maximum capacity	2ml×24, 0.5ml×36, 4-PCR8serialtubes
Timer	30seconds-99minutes-HOLD, continuous operation
Driving Motor	Brushless DC motor
Safety devices	Dual door interlock; Over-speed detector; Over-temperature detector; Error code runtime display
Powerrequirements	Single-phase, 220V-240V,50Hz/60Hz, 5A. 110V-120V, 50Hz/60Hz, 5A
Dimensions (mm)	(L) 364× (W) 280× (H) 266
Weight	12kg
Additional features	Speed/RCF switch; Pulse operation; LCD display of runtime status, buzzer notification & alert

2. Declaration of Conformity

The centrifuge:

Associated EU guidelines:
EMC: 2014/30/EU; LVD: 2014/35/EU
Construction in accordance with the following safety standards:
EN 61010-1; EN61010-2-020 CAN/CSA-C22.2 No.61010-1
Construction in accordance with the following EMC standards:
EN 61326-1 UL61010-1
This ISM device complies with Canadian ICES-001.

Changes or modifications not expressly approved by the party responsible for compliance could void the user's authority to operate the equipment.

NOTE: This centrifuge has been tested and found to comply with the limits for a Class A digital device, pursuant to Part 15 of the FCC Rules. These limits are designed to provide reasonable protection against harmful interference when the

centrifuge is operated in a commercial environment. The centrifuge generates, uses, and can radiate radio frequency energy and, if not installed and used in accordance with the user manual, may cause harmful interference to radio communications. Operation of centrifuge in a residential area is likely to cause harmful interference in which case the user will be required to correct the interference.

3. Required Operational Condition

3.1 Basic operational Conditions

(1) Power: 110V-240V, 50Hz/60Hz, 3A.

Single-phase, 220V-240V, 50Hz/60Hz, 5A; 110V-120V, 50Hz/60Hz, 5A

(2) Ambient temperature: 2°C-40°C.

(3) Relative humidity: ≤80%.

(4) No vibration and airflow around.

(5) No electric dust, explosive and corrosive gases around.

3.2 Transport and storage condition

(1) Storage temperature: -40°C-55°C.

(2) Relative humidity: $\leq 93\%$.

4. Installation

This section describes the instructions that you should abide when install the centrifuge to ensure your safety and the optimum performance. Before moving the centrifuge, the rotor must be removed.

WARNING:

- Improper power supply may damage centrifuge.
- Make sure the power source conforms to the required power supply before connecting.

4.1 Location

(1) Place the centrifuge on a firm, flat and level table, ensure the four feet of this centrifuge stand on the table firmly. Avoid installing on the slippery surface or surface prone to vibration.

(2) Ideal ambient temperature is $20^{\circ}\text{C} \pm 5^{\circ}\text{C}$, avoid placing the centrifuge in direct sunlight if temperature exceeds 30°C .

(3) Keep clear of the centrifuge at least 10cm on both sides and at least 30cm behind it to guarantee the cooling efficiency.

(4) Keep away from heat or water to avoid sample temperature issues or centrifuge failures.

4.2 Connection of the power cord and grounding

 **WARNING:**

- To avoid electrical shocks, ensure your hands are dry when touching the power cord.
- This centrifuge must be grounded properly.

A minimum 10A outlet providing a sufficient ground is required, and this must meet with local safety requirements.

5. Structure

High Speed Micro Centrifuge

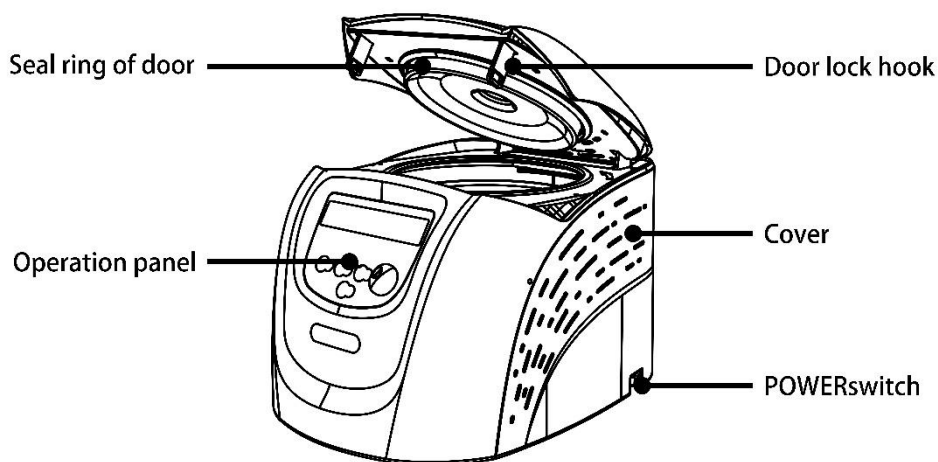

Figure 5.1 Front view of centrifuge

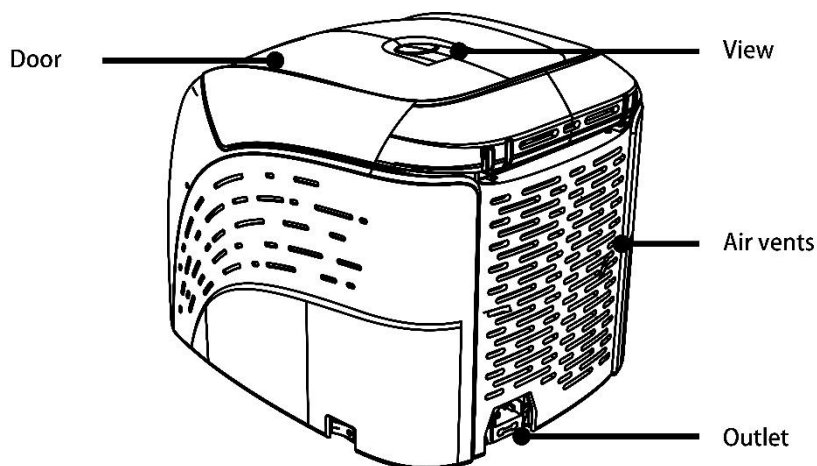

Figure 5.2 Rear view of centrifuge

6. Operation panel

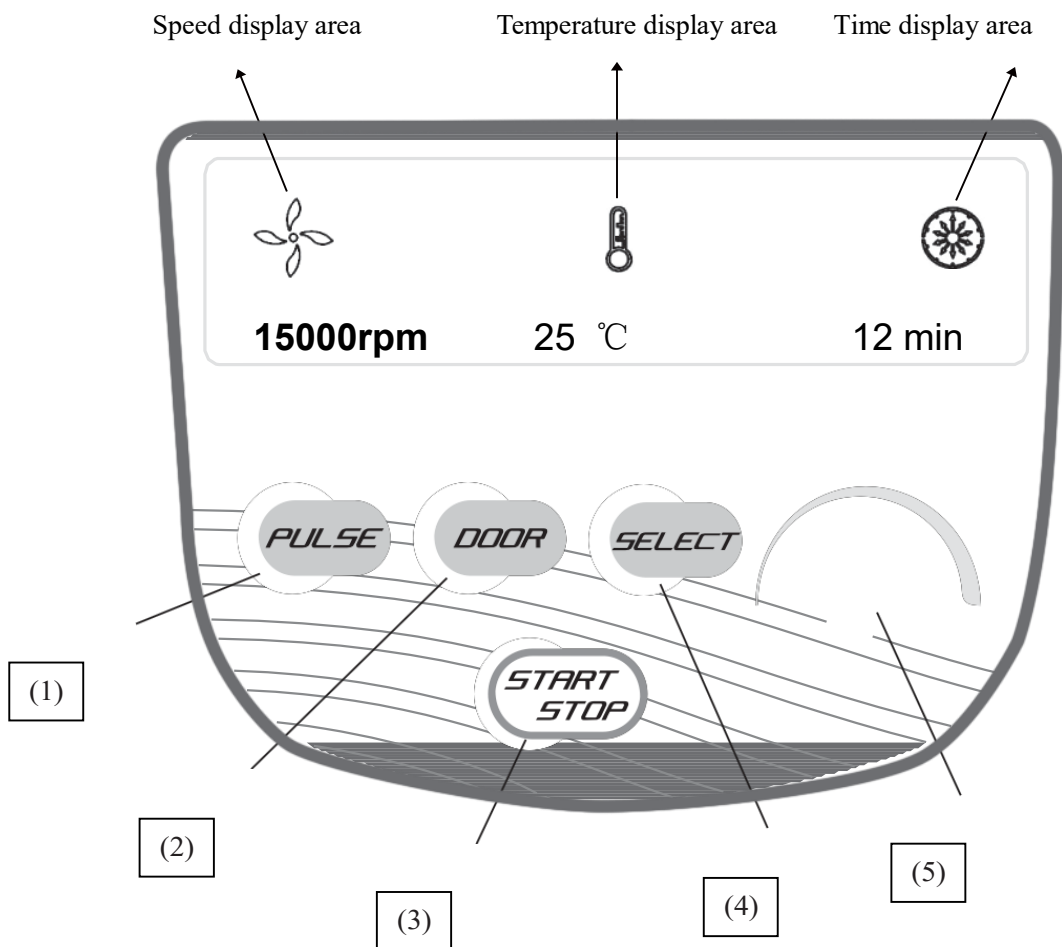







Figure 6-1 Operation Panel

Item	Symbol	Name	Function
1		Pulse button	When the door closed, press and hold the button to accelerate running, release the button to stop it.
2		Open/lock button	Press the button to open the door The button is not available when the centrifuge is running
3		Select button	Press the button to choose the parameter which you want to modify
4		Start/Stop button	Press down the button to start running. The centrifuge will brake to stop running if press the button during centrifugation.
5		Parameter button	Clockwise rotate to increase parameter values. counter-clockwise rotate to decrease parameter values. Press down the button, shift between speed and RCF display

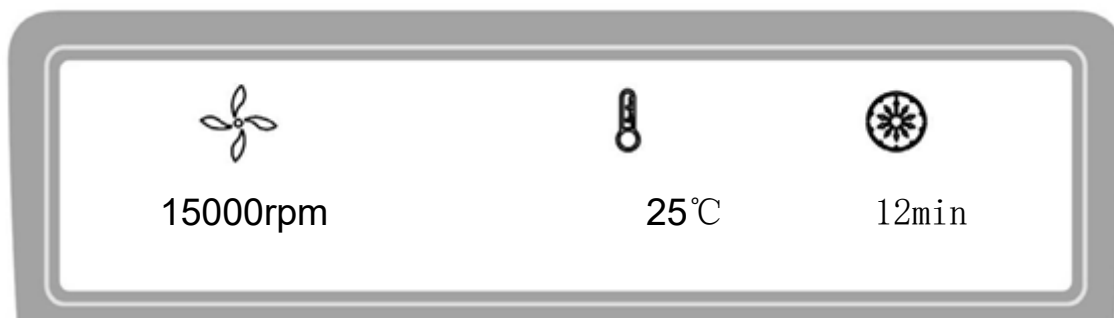



Figure 6-2 the main interface (High Speed Micro Centrifuge)

Main interface of High Speed Micro Centrifuge is as figure 6-2. The speed is set to be 15000rpm, temperature of centrifugal chamber is 25°C, and the running time is 12 minutes. When speed symbol is rotating, indicating the centrifuge is running, the rotation is faster, the speed is higher. Temperature only displays the temperature of chamber and can not be controlled. Time symbol  displays the ratio of working to time setting. The total time setting is divided into 10 scales.

7. Rotor Preparation

7.1 Prepare the samples

7.2 Inject the samples into tubes.

 **CAUTION:**

- Do not overload samples into the centrifuge which will cause leaking.
- Do not exceed the actual capacity allowed in the user manual.

7.3 Keep the tubes balance

- Although the centrifuge can accept sample balancing by eye, we recommend that you keep this centrifuge in a well-balanced condition to extend its life expectancy.
- Never intentionally run the centrifuge under unbalanced condition even though the allowable imbalance is not exceeded.

7.4 Inspect the rotor

Check the rotor for corrosion or scratches before using.

 **CAUTION:**

- Any abnormality such as corrosions or scratches are found, stop using the rotor and contact our service center.
- Only manufacturer's rotors must be used with the unit.

7.5 Symmetrically load centrifuge tubes in rotor

⚠ CAUTION:

- Make sure the rotor lid is securely fixed on the rotor, as well as the rotor and shaft are tightened. Otherwise, the rotor may be moved off while rotating and cause damage of the centrifuge and rotor.

8. Operation

⚠ CAUTION:

- Do not push or lean against the centrifuge while it is running.
- Do not run the centrifuge when fragments or sample solutions are left in the centrifuge chamber. Always keep the centrifugal chamber clean.
- If the centrifuge makes strange noise during operation, stop it immediately and contact our service center. Notify them of the warning code if displayed.

8.1 Normal Operation

Turn on the power switch, centrifuge will start self-diagnostic checks, see figure 8-1 below:

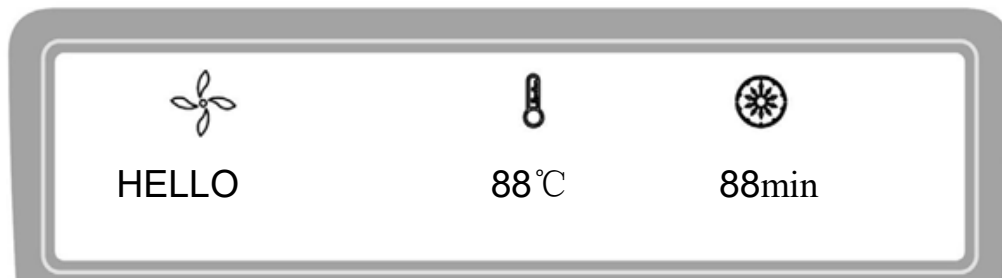
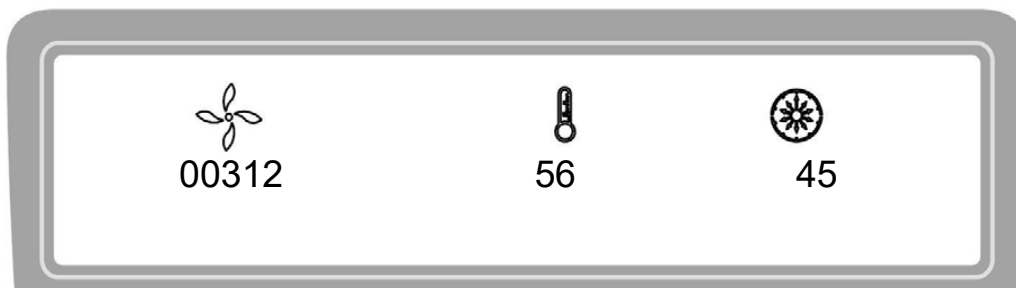

Figure 8-1 Self-checking interface

After self-checking, instrument will display accumulative running time, see figure below:



8.2 Accumulative running time interface

Figure 8-2 indicates the centrifuge has accumulated running time 312 hours 56 minutes and 45 seconds, and then the centrifuge displays the last running values, see figure 8-3 below:

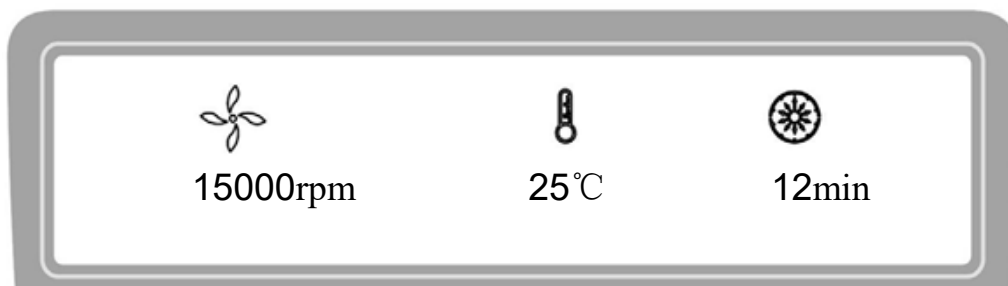

Figure 8-3Lastrunning interface

- Speed:15000rpm. Running time:12minutes.
- The door lock is released.

8.1.1Load and replace the rotor

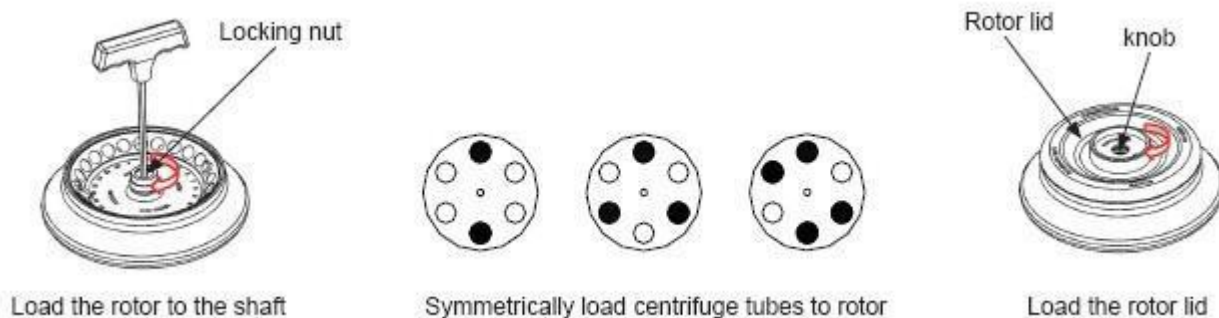





Figure 8-4Load the rotor

CAUTION







- Attach the rotor to the rotor shaft. Ensure the rotor is in position and connected with the shaft, tightening the locking nut to secure the rotor with shaft, to prevent the rotor damaging the centrifuge.
 - Ensure the rotor lid is firmly tightened to the rotor.
- Load the rotor to shaft to ensure rotor is in position until it connected with the shaft.

- You should feel a „click“ when the rotor is properly loaded to the shaft. If not, there may be something stuck between the rotor and the shaft. Double check and clean it if necessary.
- Rotate the rotor slightly with your fingers to check if the rotor vibrates. If so attach the rotor again.
- Rotate the nut clockwise using the wrench to tighten the rotor to the shaft firmly.
- Close the rotor lid, firmly tighten clockwise the lid to the rotor and ensure is in position. Close the door and then start running.
- The method of removing the rotor is as same as the above mentioned by turning the locking nut counterclockwise.



8.1.2 Set the operation parameters

Press the  button to select required parameters. The parameter can be modified when the parameter is flashing. Clockwise rotate the parameter button  to increase parameter value; counter-clockwise rotate the parameter button  to decrease parameter value. Parameter button  rotate faster, parameter value increase faster. The minimum speed increment is 100 rpm, the minimum time increment is 1 second.

(1) Set the speed

- Press the select button  until the speed rpm is displayed.
- When the speed button is selected, the speed symbol will flash the speed value.
- The minimum speed value you can set 500rpm, the minimum increment is 100rpm.
- Rotate program button clockwise  to increase speed value, rotate the program button anti-clockwise  to decrease speed value.
- You can speed-up set the speed value by rotating program button  quickly.
- There is a circulating function to increase/decrease the speed values. Rotate the program button clockwise  to change settings from small → large → maximum → minimum. Rotate the program button anti-clockwise  to change settings from large → small → minimum → maximum.

(2) Set the time



- Press button , time value flashes in the time setting mode.
- Rotate the program button  to set running time from 30 seconds to 99 minutes.
- When time displays HD, this is a continuous running mode.

8.1.3 Start the operation

(1) Press running button  to start running

- The door should be locked before rotor starts rotating.
- Timer will operate once the speed setting value is reached, the screen displays the remaining run time.

(2) View and modify the operation programs

- Pressing button , returns the display to the program interface and displays settings programs. Press the select button  to the desired program. When flashing, rotate parameter button  to modify values. Release the button after 5 seconds, and the centrifuge will return to normal operation mode and run according to the new value.
- If the set time value has been modified, the operation time is not affected and will continue.

(3) Warning display

- If an error occurs during the operation, the centrifuge will brake to stop automatically, and display the error code on the time/display area. The error code can be checked in the table 10-1, and corrective actions can be applied accordingly.

8.1.4 End the operation

(1) The centrifuge will brake when it reaches the setting time or  button is pressed.

- When the rotor stops rotating, centrifuge will start beeping to alert the operation has finished.

(2) Open the door

- The door can be released automatically when the operation has stopped.
- With the door closed, you are able to press the  button to open it.
- After ending the operation, the program will store the setting parameters of this operation, and will recall these parameters when restart the program.

(3) Open the door and take out the rotor and samples.



8.2 RCF Operation

(1) Turn on the power switch.

(2) Set a RCF (Relative Centrifugal Force) value.

CAUTION

- Do not exceed the allowable maximum RCF value of the rotor and adapters.

- Press the select button  and choose speed unit $\times g$, the speed symbol will flash into RCF value input status.
 - If no button is pressed after the speed value has flashed for 5 seconds, the input mode will be shut down.
 - Rotate program button  to input a RCF value, RCF increment is $100\times g$.
- (3) Set operating conditions
- The other operation, please refer to the section 8.1.

8.3 Pulse Operation

This function is used to remove the residual samples adhered on the interior of the tubes.

Note: The button works only when the rotor stopped and the door is locked.

(1) Turn on the power switch and load the rotor to the shaft, tighten the rotor lid and make sure it is in secured position, and then close the door.

(2) The centrifuge gets into preparation mode and displays last running values.

The values can be reset.

(3) Press  knob and hold, the centrifuge will speed up to the setting speed.

While releasing  knob during acceleration, the centrifuge will start to decelerate

and stop.

9. Maintenance

9.1 Cleaning

CAUTION

- If do not follow the recommended instructions for cleaning or disinfecting may damage the centrifuge.

(1) Centrifuge

- If the centrifuge is exposed to ultraviolet rays for a long time, the color of the doors may be changed or the label may be came off. After using, cover the centrifuge with a piece of cloth to protect it from direct exposure.
- If the centrifuge needs cleaning, clean it with a cloth or sponge moistened with a neutral detergent solution.
- Sterilize the centrifuge by wiping with a cloth moistened with 70% ethanol solution.

(2) Rotor chamber

⚠ CAUTION

- Do not directly pour water, neutral detergent or disinfectant solution into the rotor chamber. Otherwise fluids may leak into the drive units and cause corrosion or deterioration to the bearings.
-
- If the rotor chamber needs cleaning, clean with cloth or sponge moistened with a neutral detergent solution. Sterilize the centrifuge by wiping with a cloth moistened with 70% ethanol solution.
- (3) Drive shaft
- We recommend regular maintenance for drive shaft. You can wipe the drive shaft with soft cloth, and then apply a thin coat of silicon grease.
- (4) Door
- Clean and sterilize the door using the same method as the step (1) above.
- (5) Rotor
- To prevent corrosion, remove the rotor from rotor chamber. If not in use for a lone term, then detach the rotor lid and turn upside down to dry the tube holes and keep clean.
 - For sample leaks in the rotor, rinse the rotor with water. Apply a thin coat of silicon grease to the rotor when it is completely dry.

- The rotor should be regular maintenance, recommend to cleaning it each 3 months to ensure tube and rotor holes keep clean, and then apply a thin coat of silicon grease.

9.2 Consumables

Replaceable wearing parts listed below. It is recommended to replace these according this table.

Item.	Replacement parts	Replacement conditions
1	Seal ring of door	Cracked
2	Rubber block of temperature sensor	

9.3 The replacement of seal rings

9.3.1 Instructions

There are three high-temperature rubber seal rings that equipped into rotor to achieve bio-safe. The seal rings may fall off or aging after several autoclaving, need to be replaced or re-installed.

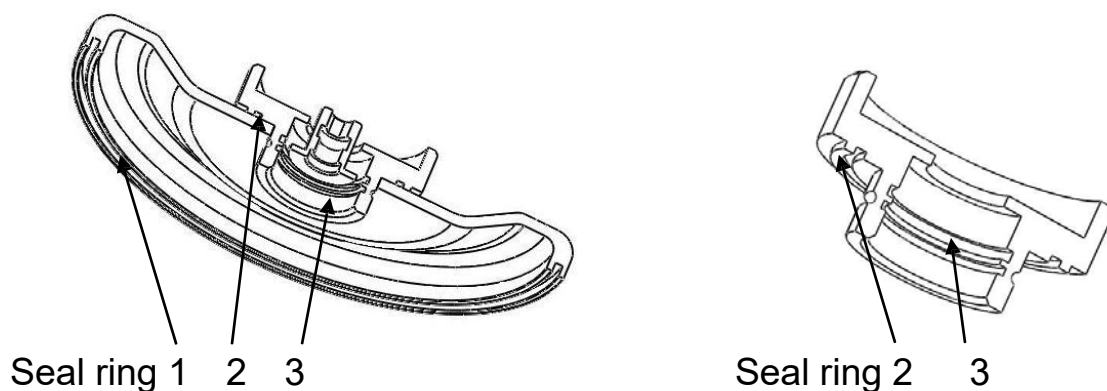

Figure 9-1 Seal rings of rotor

9.3.2 Replacement methods

- (1) Clean the seal ring slot with neutral detergent solution and make it dry.
- (2) Evenly coated with glue (501) in the seal ring slot and keep the seal ring into slot, press evenly to make it contact enough with the slot bottom and bond firmly.
- (3) Place for 20 minutes and waiting for the glue to completely solidified.

9.4 Routine inspection

- (1) Check that if the centrifuge is on a firm, flat and level table, ensure the four feet stand on the table firmly.
- (2) Check if the centrifuge grounded properly: Use multi-meter to check if is short circuit between the power cord grounding pin and the motor shaft. If yes, indicating grounded properly; if is open circuit, need to check failure reason first and make troubleshooting before use.

10. Troubleshooting

10.1 Possible problems and solutions

This centrifuge has a self-diagnostic function. If a problem occurs, an error/warning code will be displayed on the time display screen and the operator can determine the malfunction with the warning code below.

Table 10-1 Possible problems and solutions

Symptom	Causes	Solutions
Nothing appears on the screen when the	<ul style="list-style-type: none"> · Building power circuit breaker trips. · the fuse was blown out. 	<ul style="list-style-type: none"> · Remove the trouble and turn on the POWER. · Replace the fuse.
Error code appeared on the time display screen	E-02 Door fault	<ul style="list-style-type: none"> · The door opened in running. · Press the button  while the door opening.
	E-04 Temperature fault	<ul style="list-style-type: none"> · The air inlets are blocked. · Radiator fan is damaged.

E-06 Set wrong parameter	The setting parameter exceed the allowable range.
E-10~86	Read the maintenance manual.

10.2 How to open the door

10.2.1 In the case of power on

CAUTION

- The door just can be opened while the power on and rotor stops rotating.

- (1) Turn on the POWER switch, the door lock will release automatically.
- (2) The door lock will release automatically once the operation finished.
- (3) It is available to release the door by pressing button  once the rotor stops.

10.2.2 In the case of power outage

The door cannot be opened automatically if there is a power outage. It is available to be opened manually.

- (1) Ensure if the rotor has stopped rotating.
- Listen carefully to ensure no rotating sound can be heard.

(2) Insert a screw driver into the hole to open the door.

- Hole is located on the top right side of the unit.
- Insert a screw driver into the hole and push forward to release the door.

10.3 Replacement of fuses

(1) There are two fuses of High Speed Micro Centrifuge, 250V, 5A time-delay type, size: $\Phi 5 \times 20$. There are two fuses of

(2) The fuse holder is located in the power inlet. Pull out the fuse holder from power inlet and replace the fuses if necessary.

11. Instructions of rotor and tube

CAUTION:

- Read the instructions thoroughly, correct use rotor.
- Do not exceed the allowable maximum speed of rotor, tube and adapters etc. be care that the allowable maximum speed of some adapters are lower than the rotor's maximum speed.

11.1 The rotor instructions

11.1.1 Rotor structure

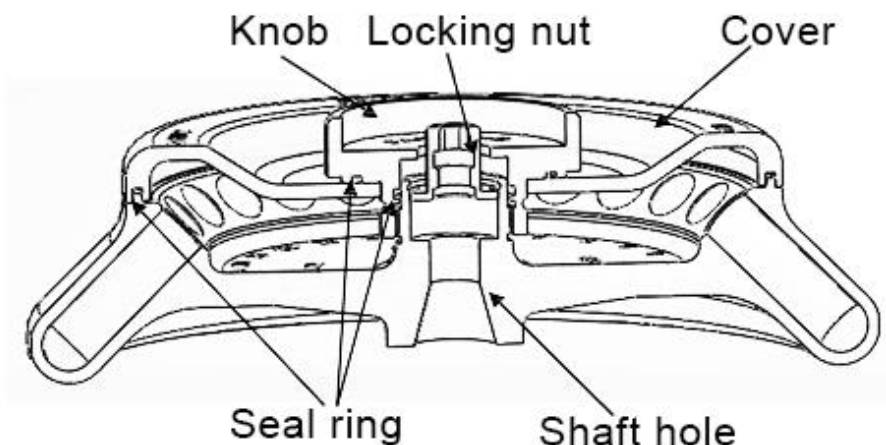

Figure11-1 the rotor profile

11.1.2 Available rotors and adapters

All rotors are used for bio-safe when the rotor lid was tightened with the rotor, centrifuge tubes will be enclosed into rotor to ensure the sample does not leak in centrifugal process. If rotor lid is not available, the rotor would be no bio-sealing function. The rotors can be used as follows:

Rotor type	ID code	Tube/bottle	Adapter	Maximum speed (rpm)	Maximum centrifugal radius rmax(cm)	Maximum RCF Rcf (×g)

1	AS24-2	2/1.5ml tube		15000	8.5	21380
		0.2mlPCR tube	A02P2	15000	6.9	17350
		0.5mlmicro tube	A05P2	15000	7.6	19100
2	AS36-05	0.5mlmicro tube		15000	8.5	21380
		PCR8 serial tube	A02P05	15000	7.6	19100
3	AS4-PCR8	PCR8 serial tube			6.5/7.2	16350/18100
4	AS12-V5	5mL conical tube		15000	8.5	21380
5	AS18-5	5mL culture tube		15000	8.5	21380

Table11.1Rotors and adapters

11.1.3 Notice

(1) The centrifuge rotor can separate sample which density lower than 2.0g/ml, if

the samples density is over 2.0g/ml, please calculate allowable speed depending on the following formula. Allow Speed (rpm)= Maximum speed×(2.0(g/ml)/Sample density (g/ml))^{1/2}

(2) To prevent corrosion, remove the rotor from rotor chamber if do not use for a lone term, then detach the rotor lid and upside the rotor down to dry the tube holes.

(3) If some samples leaked in the rotor hole, wash the hole with water, apply a thin coat of silicon grease on the rotor surface after drying.

(4) It is necessary for a regular maintenance for rotor, recommend to clean it each 3 months to keep cleaning of tube hole and shaft hole, and then apply a thin coat of silicon grease on it.

(5) **Special note: To avoid safety hazards of the centrifuge due to long periods of non-use by the customer . The product is equipped with a door lock hibernation protection function. When a product has not been in operation for a long time (especially a new product) and is back in use. The centrifuge hatch must first be opened manually from the side door using a spanner. Release the hibernation protection and you can use it normally afterwards.**

11.1.4 Autoclaving

The rotor is manufactured in high-strength aluminum alloy material and can be

autoclaved: 121°C (1.0kg/cm²), 20minutes.

11.1.5 Bio-safe seal ring

The rotor is sealed by bio-safe structures, achieved using three high-temperature rubber seal rings. The seal rings may fall off or aging after several autoclaving, need to be replaced or re-installed. The replacement methods please refer to the section 9.3.

11.2 Tubes

11.2.1 Cleaning and sterilizing tubes

Table 11.2 Cleaning and sterilizing conditions for tubes

O: Applicable X: Inapplicable

Condition		Material	PA	PC	PP
Cleaning	Cleaning fluids	Acidic (pH5 or lower)	X	X	X
		Acidic (higher than pH5)	O	O	O
		Alkaline (higher than pH9)	O	X	O
		Alkaline (pH9 or lower)	O	O	O
		Neutral (pH7)	O	O	O
		Warm water(up to 70°C)	O	O	O

	Ultrasonic cleaning	Neutral detergent (pH7)	O	O	O
Sterilization	Autoclaving	115°C (0.7kg/cm ²) 30minutes	O	O	O
		121°C (1.0kg/cm ²) 20 minutes	X	O	O
		126°C (1.4kg/cm ²) 15 minutes	X	X	X
	Boiling	15 to 30 minutes	O	O	O
	Ultraviolet sterilization	200-300nm	X	X	X
	Gas sterilization	Ethylene oxide	O	X	O
Formaldehyde		O	O	O	

PA: Polyallomer; PC: Polycarbonate; PP: Polypropylene

11.2.2 Cleaning PC tubes

PC materials are low in chemical resistance against alkaline solutions. Avoid using neutral detergents with pH higher than 9. Note that pH of some neutral detergents are still higher than 9 even if diluted according to the instruction in the maker's catalog. Use detergent with its pH between 7 and 9.

11.2.3 Autoclaving PA, PC and PP tubes

PA begins softening at about 120°C, PC and PP at about 130°C. Autoclave PA tubes at 115°C (0.7kg/cm²) for 30 minutes and PC and PP tubes at 121°C (0.1kg/cm²) for 20 minutes. If a certain temperature is exceeded, the tubes may be deformed.

When using a sterilizing chamber, please operate as follows:

- (1) Place tubes in vertical position, mouths upward. If tubes are placed sideways, they may deform into an oval shape due to gravity.
- (2) Remove screw nuts and inner covers to prevent from deformation or rupture.
- (3) Wait until the sterilizing chamber cools down to the room temperature before the tubes are removed.

11.2.4 Condition and life expectancy of tube

The life expectancy of plastic tubes depends on the characteristics of samples, speed of the rotor used, and temperature applied, and so on. When the plastic tubes are used for centrifuge of ordinary aqueous samples (pH between 5 and 9), their life expectancies are defined as follows.

Be operated at the maximum speed:

High quality tubes (PA、PC、PP): 30-50 operations

Ordinary tubes(PA、PC、PP): around 10 operations (Using in low speed can extend

the tube life) .

Life expectancy of tubes also depends on the pretreatment conditions such as cleaning and sterilization, lifetime can be cut down.

Notice: Do not use damaged or cracked tubes.

12. Calculation Relative Centrifuge Force (RCF)

Relative Centrifuge Force (RCF) can be determined with the following calculation formula.

$$RCF=1.118 \times r \times n^2 \times 10^{-5}$$

R—rotating radius, unit: cm; n—rotating speed, unit: rpm

13. Warranty

13.1 Warranty of the centrifuge

This centrifuge is guaranteed for two years from the date of delivery provided that it has been operated and maintained properly.

13.2 Warranty of the rotor

The rotor is guaranteed for 5 years from the date of delivery upon manufacture.

Please pay attention, do not use the rotor once it has been corrosion or fatigue damage. We do not guarantee this centrifuge and the rotor under the following

conditions even if within the guarantee period expires:

- (1) Failures caused by incorrect installation.
- (2) Failures caused by rough or improper handling.
- (3) Failures caused by conveyance or relocation after installation.
- (4) Failures caused by unauthorized disassembly or modification.
- (5) Failures caused by using parts of the other companies, such as rotors and adapters.
- (6) Failures caused by natural disasters including fire, earthquakes and so on.
- (7) Consumables and parts have a limited guarantee period

14. After-sales Service

In order to ensure to operate centrifuge safely and efficiently, it is necessary for regular maintenance. If centrifuge has problems, do not attempt to repair it by yourself. Contact our sales or service center.

Контактная информация сервисных центров

Сервисный центр Диаэм в Москве:

Адрес: 129345, г. Москва, ул. Магаданская, д.7, стр.3

Тел.: +7 (495) 745-05-08 (многоканальный)

E-mail: service@dia-m.ru

www.dia-m.ru

Сервисный центр Диаэм в Новосибирске:

Адрес: 630090, Новосибирск, Академгородок, пр. Ак. Лаврентьева, 6/1, офис 100А

Тел.: +7 (495) 745-05-08 (многоканальный)

E-mail: service@dia-m.ru

www.dia-m.ru

Сервисный центр Диаэм в Казани:

Адрес: 420111, Казань, ул. Профсоюзная, д.40-42, пом. № 8

Тел.: +7 (495) 745-05-08 (многоканальный)

E-mail: service@dia-m.ru

www.dia-m.ru

Сервисный центр Диаэм в Санкт-Петербурге:

Адрес: 197022, Санкт-Петербург, ул. Профессора Попова, д. 23, лит. Д, офис 614 (БЦ «Гайот»)

Тел.: +7 (495) 745-05-08 (многоканальный)

E-mail: service@dia-m.ru

www.dia-m.ru

